

Installation Instructions

Lexus UX / UXh (19-up)

KIT CONTENTS:



Large anti-abrasion film pad (3)



Automotive surface cleaner (1)

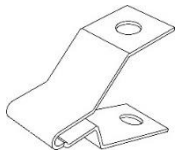

Metal mounting bracket Type A (2)

Screw (6)

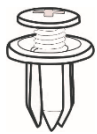

Push type retainer (6)

Small anti-abrasion film pad (2)

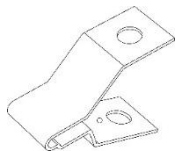
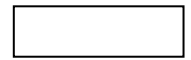

Metal mounting bracket Type B w/ hole (1)

Metal mounting bracket Type C (2)

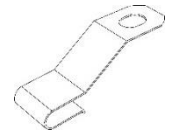

Round bumpon (7)

Pin (6)

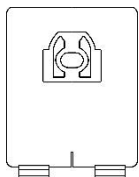

Large adhesive pedestal (2)

Hood deflector (1)

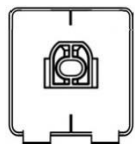

Small adhesive pedestal (4)

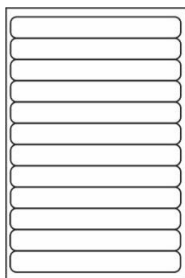
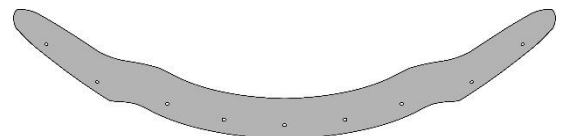

Tape strip sheet (1)

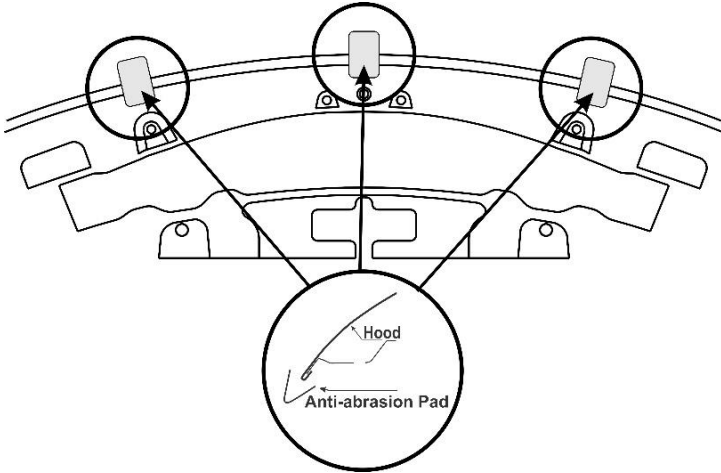

1. Be sure that the hood is clean and dry inside and out.
 2. Open the hood of the vehicle.
- ⚠** Peel and fold large anti-abrasion film pads in half over the edge of the hood, in the three (3) locations shown.

Metal mounting bracket guide

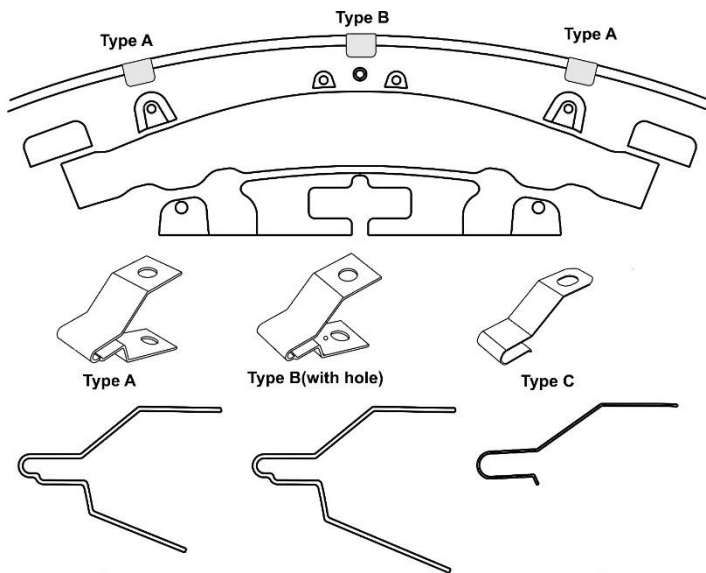

NOTE:
Use the metal mounting bracket guide to determine where the metal mounting brackets are installed in the following steps.

3. Install the two (2) Type A and one (1) Type B metal mounting brackets on the hood edge over the large anti-abrasion pads.
- Align the hole in the bottom leg of the bracket with the round hole in the hood.

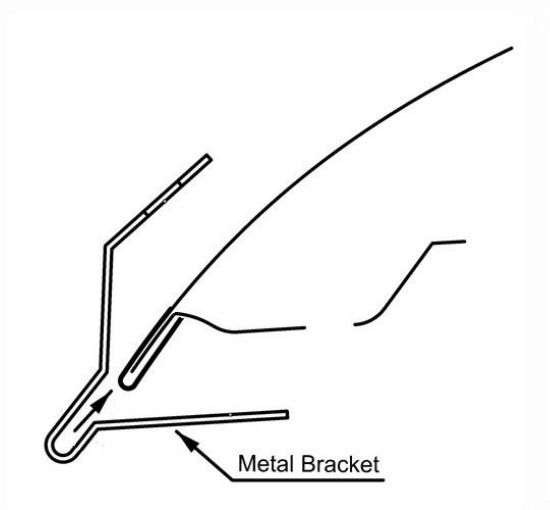

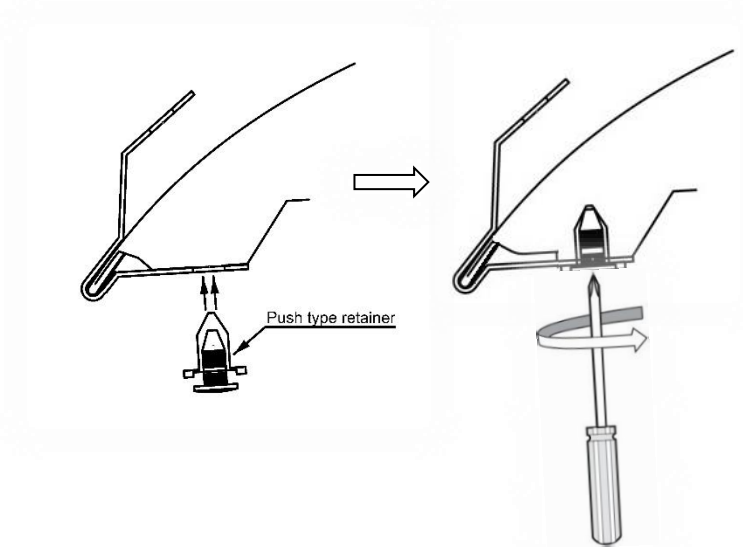

4. Insert a push type retainer through the Type A and Type B metal mounting bracket, and into the hood.

⚠ Ensure the leg of the bracket is well seated against the surface of the hood and **push the center pin of the retainer assembly using a #2 Phillips screwdriver followed by tightening 90 degrees** to fully engage the retainer into the hood and lock it into place.

REPEAT FOR OTHER SIDE

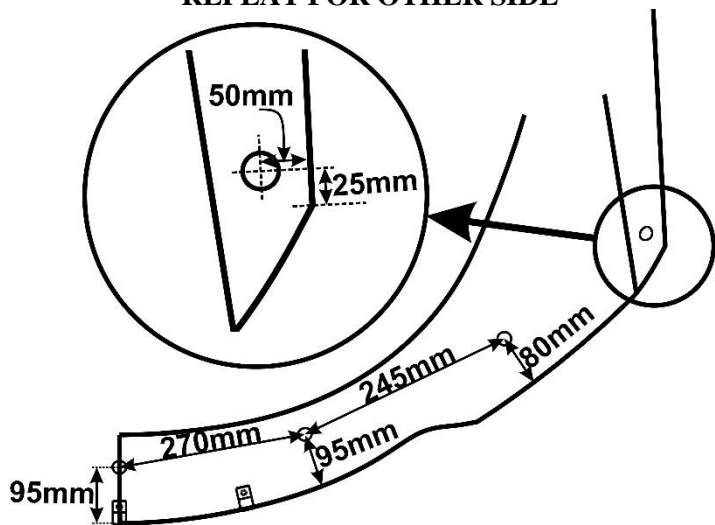

5. Install the seven (7) bumpons in the locations shown.

ATTENTION:

⚠ **Bumpons must be installed on the hood, not on the hood deflector!!!** If the bumpons are installed on the hood deflector, they may wear through the vehicle paint.

NOTE:

Locate the center bumpon using the center line of the Type B metal mounting bracket.

REPEAT FOR OTHER SIDE

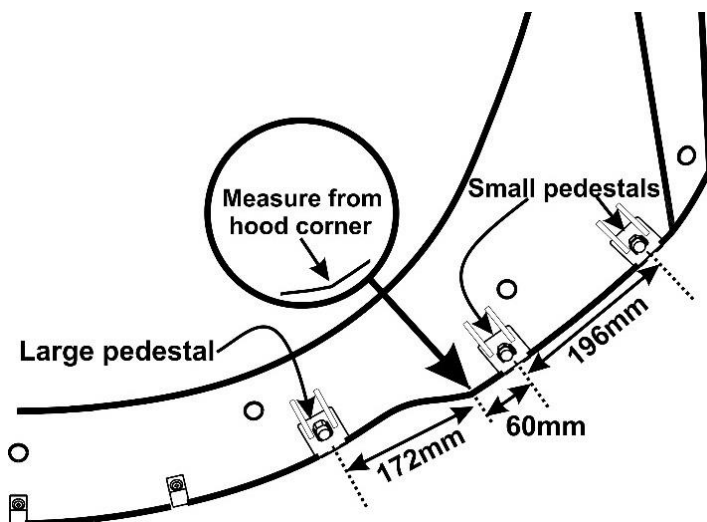

6. Dry fit the adhesive pedestals using the supplied tape strips or masking tape to temporarily hold them in position.

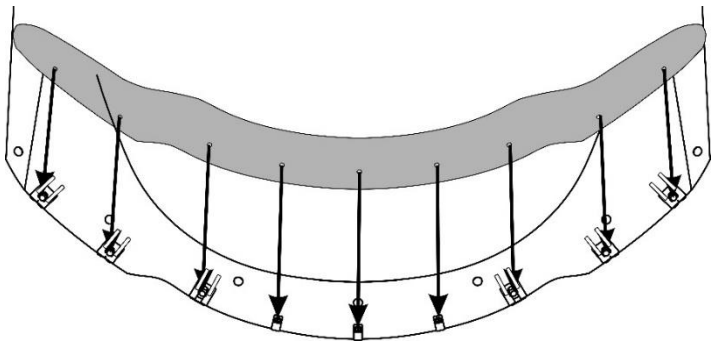

- Place the hood deflector temporarily onto the Type A and B metal mounting brackets and align the holes in the hood deflector with the holes in the metal brackets. This will allow for checking the position of the adhesive pedestals and any readjustments if necessary.

TIP:

Temporarily insert a push type retainer through the hood deflector center hole and into the Type B metal mounting bracket. This will help stabilize the hood deflector while making readjustments.

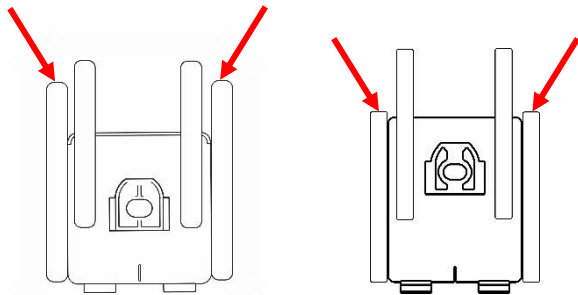
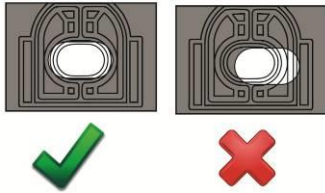

- Remove the hood deflector and outline the perimeter of the adhesive pedestals with masking tape or tape strips to help with final installation.

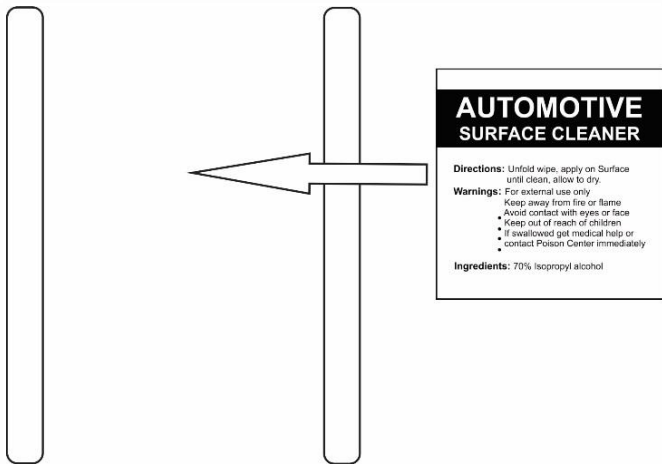

- Remove the adhesive pedestals and thoroughly clean the outlined area with automotive surface cleaner. Wipe dry with a clean cloth or paper towel. This will insure all wax, finger prints, and oils are removed from the hood surface in the bonding area.

IMPORTANT:



Proper preparation of the hood surface will ensure maximum adhesive bond.

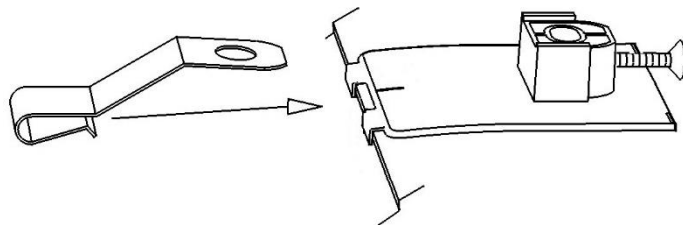
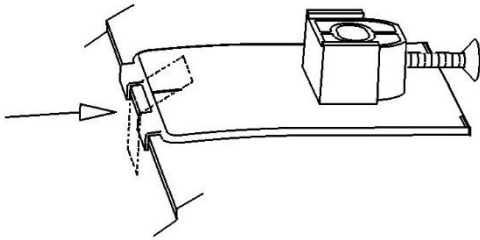
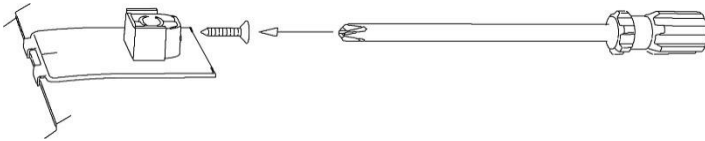
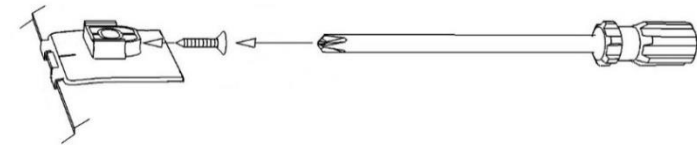
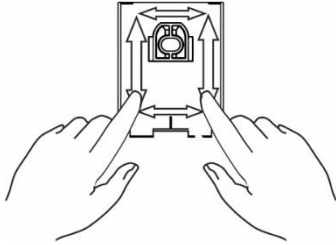
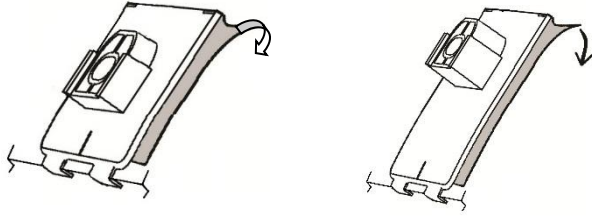

10. Remove the protective backing from the adhesive on the pedestals and install on the hood surface.

CAUTION:
 Avoid contaminating the adhesive surface.

TIP:
 Hook the fingers on the pedestal over the hood edge and rotate the unit into position. After installation, remove the masking tape or tape strips and “wet out” the adhesive to the hood surface by applying pressure with your thumb around the surface of the pedestals.

IMPORTANT:
 “Wetting out” of the adhesive pedestals will ensure maximum adhesive bonding.

11. Start a screw into each adhesive pedestal a few turns.

NOTE:
 The tip of the screw must not protrude into the hole where the attachment pin will install later.

12. Peel and fold a small anti-abrasion film pad in half over the hood edge between the fingers of each large adhesive pedestal.

13. Push a Type C metal mounting bracket over the hood edge on top of the anti-abrasion pad installed in the previous step. Ensure the bracket is fully engaged over the hood edge and the hole in the bracket is aligned with the hole in the large adhesive pedestal.

14. Place the hood deflector on the hardware mounted to the hood and align the three (3) holes in the hood deflector with the holes in the Type A and B metal mounting brackets.

Insert a push type retainer through the hole in the hood deflector and into the bracket.

-  Ensure the hood deflector is well seated against the metal bracket and **push the center pin of the retainer assembly using a #2 Phillips screwdriver followed by tightening 90 degrees** to fully engage the retainer into the bracket and lock it into place.

15. At the adhesive pedestal locations, drop a pin through the hood deflector and into the pedestal.

16. Tighten the screw while maintaining slight pressure on the pin, to ensure proper seating of the components.

CAUTION:

-  Use care to avoid damaging the vehicle surface while tightening the screws.

On some vehicles, it may be necessary to adjust the hood bumpers and/or latch for proper clearance.

Do not use chemicals or solvents.

Periodically check to make sure the hood deflector is secure.

Avoid using automatic car washes.

Do not pull on the hood deflector when opening or closing the hood.

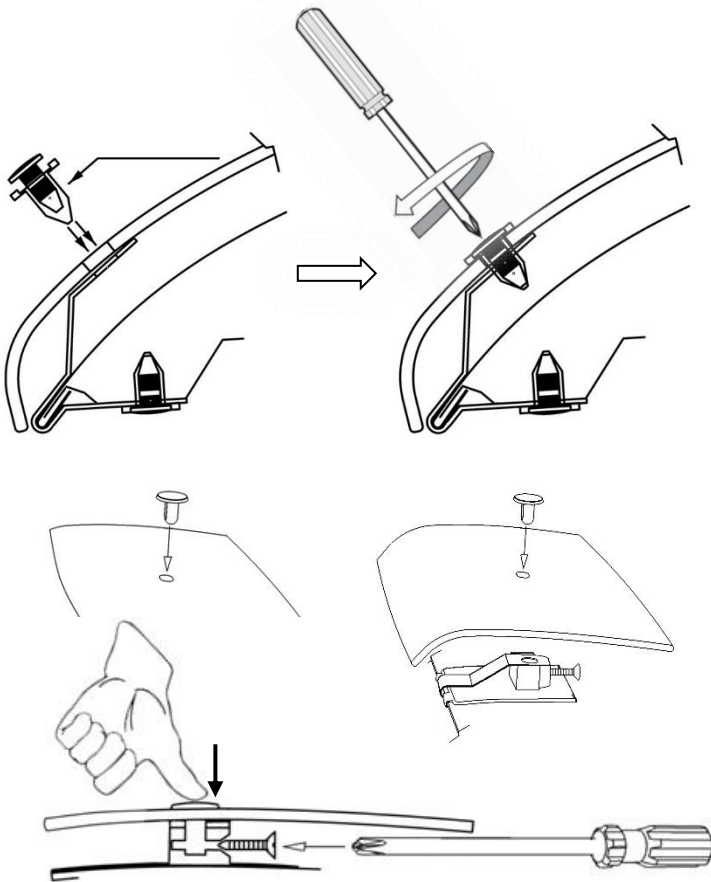

CAUTION:

-  Do not expose the vehicle/hood deflector to extreme environments (weather) or car washes for a 24-hour period following the installation to allow the adhesive pedestals sufficient time to reach full bonding strength.

CARE INSTRUCTIONS:

Clean the hood deflector with a mild soap and water solution or plastic cleaner only.