

# FormFit Accessories

SD 10K18











Vehicle Model	Kona	Accessory	Side Window Visors
Model Year	2018-	Difficulty	(B)
Part No.	SD 10K18		

## Accessory Installation



**Note:** Difficulty stated above reflects the minimum level of expertise required to install the accessory.

( A ) Customer ( B ) Dealer Technician ( C ) Master Technician

## Instructional Symbols / Definitions

	Denotes warnings that may lead to serious physical injury or vehicle damage.		Denotes quality processes to be checked prior to moving to the next step.	Denotes safety equipment required to be used such as a mask, safety glasses, gloves, and hearing protection.	
	Denotes cautions to be taken to avoid physical injury or electronic component damage.		Denotes specific tools that are necessary to complete the step.		
	Denotes cautions to be taken to avoid vehicle and component damage.		Denotes instructional steps necessary to complete the process.		
				Mask	Safety Glasses
				Gloves	Hearing Protection

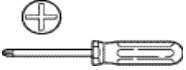
## Basic Required Hand Tools

		
#2 Phillips Screwdriver with LONG SHANK	Clean Cloth	

## Notes to the Installer:

Read the entire installation manual prior to beginning the installation of the accessory.

To prevent vehicle damage, never place tools on top of painted surfaces, seats, dash pad, console or floor carpet / mat.

Always wear appropriate safety gear to include gloves and eye protection when required.

Make sure the vehicle is clean and completely dry before installation.

Make sure the vehicle is at room temperature or warmer: 15° to 43°C (60° to 110°F) before starting installation and that it remains at room temperature for 1 hour afterward to develop maximum adhesion of the 3M tape to the vehicle's surface.

<p><b>3M Primer 94 Instructions</b></p> <ul style="list-style-type: none"> <li>-Squeeze tube in middle to break inner ampule</li> <li>-Apply to clean, dry surface</li> <li>-Allow at least 5 minutes to dry before taping</li> </ul>
---

## FormFit Accessories Installation Kit Contents

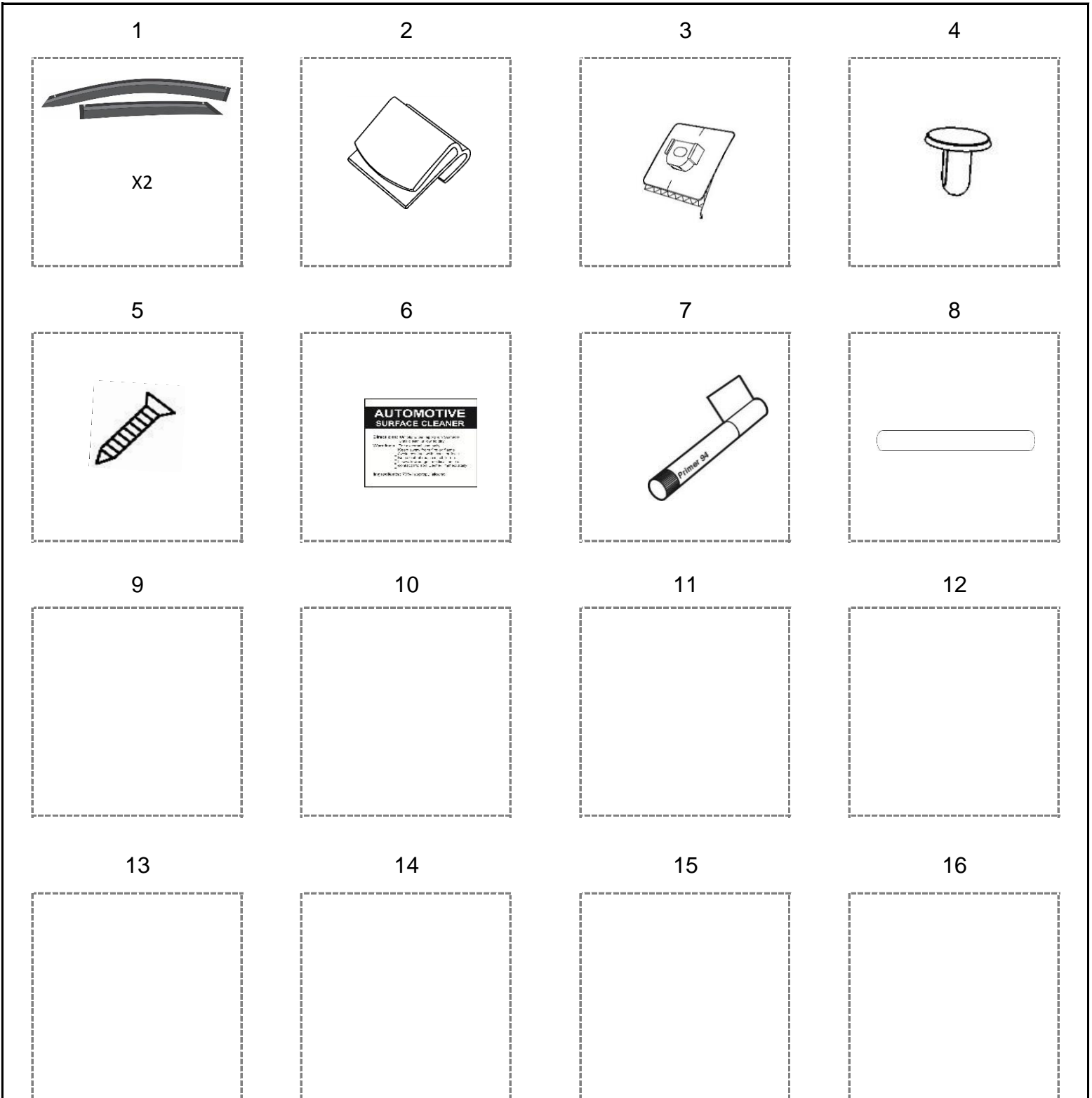

#	Qty.	Description	#	Qty.	Description	#	Qty.	Description
1	1	Side window visors (set of 4)	7	2	Primer 94 Ampules	13		
2	8	Plastic clips	8	1	"Wet-out" Stick	14		
3	4	Small adhesive pedestals	9			15		
4	4	Pins	10			16		
5	4	Screws	11					
6	2	Surface Cleaner	12					

## FormFit Accessories

### INSTALLATION

- Make sure the vehicle is clean and completely dry before installation.
- This product uses a 3M adhesive that requires installation and curing temperatures of 15° to 43°C (60° to 110°F) for 1 hr to develop maximum adhesion to the vehicle surface. Failure to install this product at the proper temperature or allow adequate curing time before use is not covered under warranty.
- Proper installation of the adhesive pedestal system requires the use of a #2 Phillips screwdriver. Use of the correct screw driver will facilitate a trouble free installation. Do not attempt to use #1 or smaller Phillips screwdriver or any type of electric screwdriver.

### CARE

Hand clean visors using a mild soap and water solution or plastic cleaner only. Avoid automatic car-wash equipment where a brush and/or soft cloth come in contact with the visors. Touch-less style automatic car-wash equipment is less likely to harm them.

### SERVICE

Periodically check to confirm the protector is securely attached to the vehicle.

### WARNING

Do not pull/push on the visor when opening/closing the door.

## FormFit Accessories

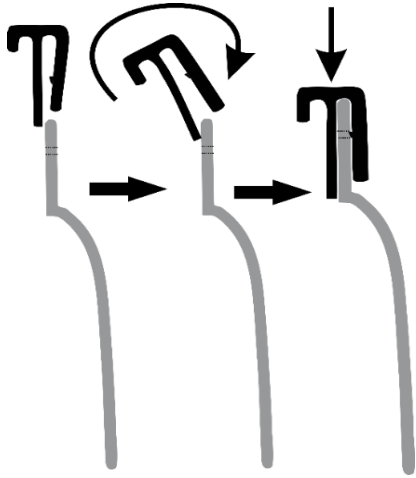

### Attach mounting clips

1

NOTE

Each visor receives two clips. Note the orientation of the clips. The open "hook" must be on the edge facing the door frame. The clips sit in the recess on the visor and the small locating pin snaps into the hole in the visor. See illustration.

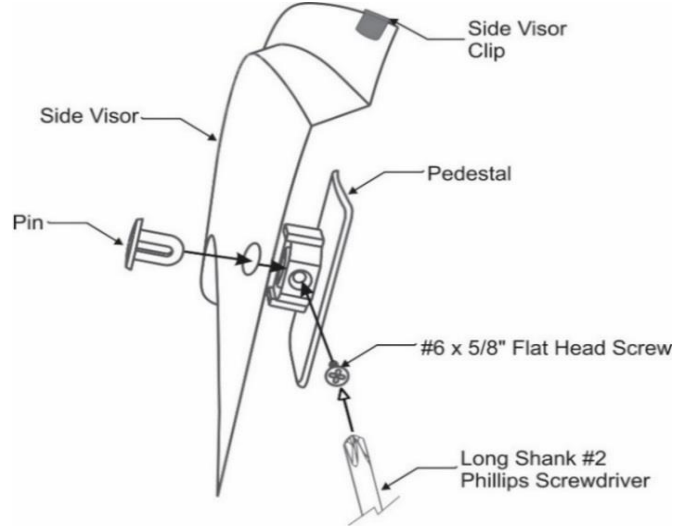

### Assemble mounting pedestals

2

NOTE

Insert a pin through the hole in the side visor and into the adhesive backed pedestal. Note: See next illustration for pedestal orientation. Maintain slight pressure on the pin, to ensure proper seating of the components, while simultaneously tightening the screw. Repeat for other three pieces.

**Do not overtighten the screws.**

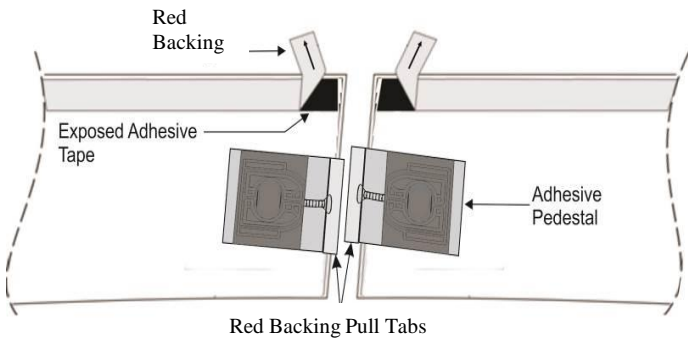

### Pedestal Orientation

3

NOTE

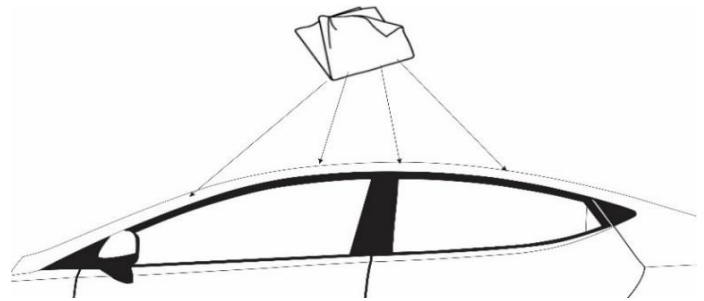

### Clean window frames

4

NOTE

The visor mounts to the window frames of the vehicle. Ensure those areas are clean and dry.

## FormFit Accessories

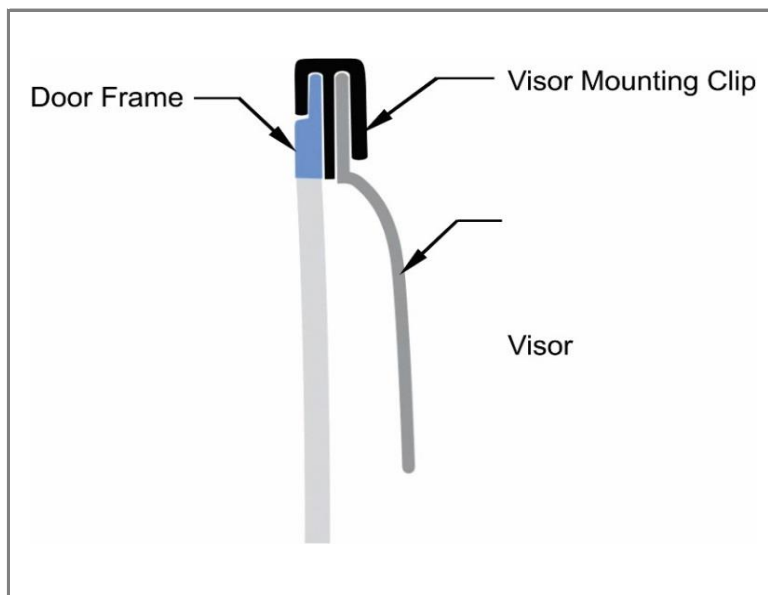

### Test fit visors on driver's side Pt 1

5

NOTE

Test fit the visor to the door frame before attempting final installation. Open the front door and place a front visor into position by hooking the mounting clips (already attached to the visor) over the top edge of the door frame. See illustration.

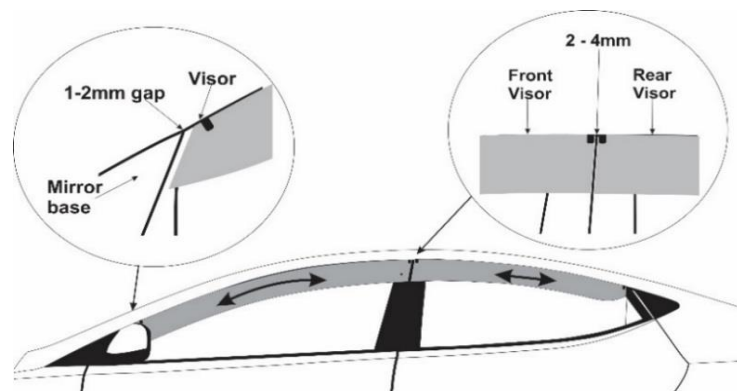

### Test fit visors on driver's side Pt 2

6

NOTE

Center the visor on the door, front-to-back. The visor is 3-4mm shorter than the door so there will be a 1-2mm gap at the mirror base and at the rear edge of the door. These gaps allow for expansion on hot days. Repeat this step for the rear door visor. There will also be a 1-2mm gap at each end.

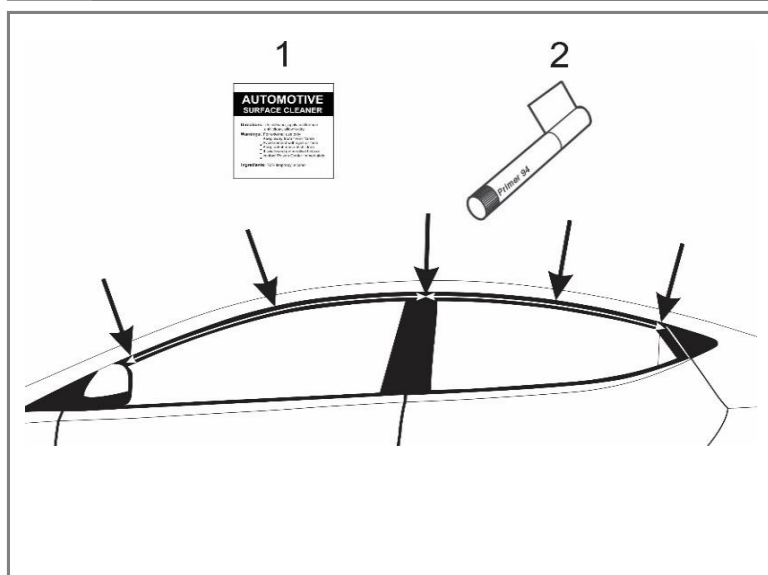

### Clean and prime mounting surface

7

NOTE

Clean all the mounting areas aggressively with the automotive surface cleaner to remove any finger prints, oil or wax that may be on the surface. Wipe dry with a clean cloth or paper towel. Using the 3M adhesive promoter prime all the contact areas on the door frames where the visors and the pedestals mount. Allow to dry. Excess primer can be removed with alcohol. See page 1 for Primer 94 instructions

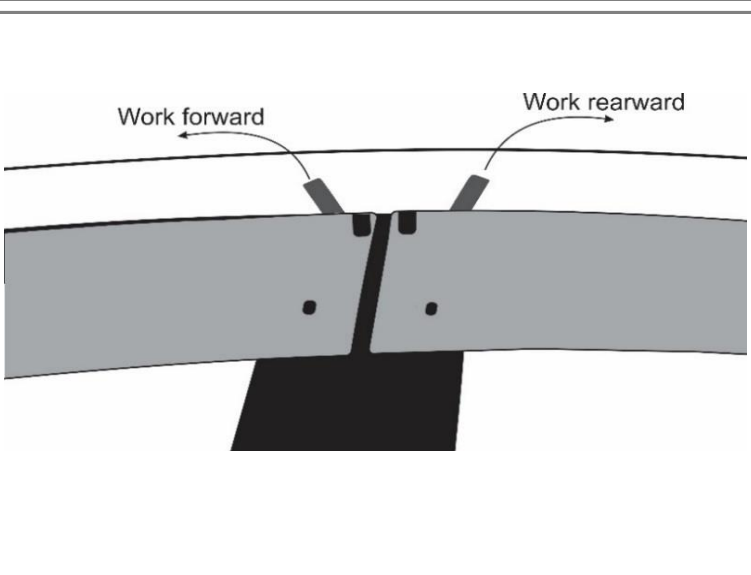

### Mount visors on driver's side

8

NOTE

Ensure each clip is seated and the visor is located as determined in step 5. Starting at the pedestal end, peel the first 5-10 cm (2-3 inches) of the red backing from the adhesive tape on the flange of the visor. Working forward, remove the red backing from the tape and press the part into place. Once the visor is in place press down hard along the entire flange area to make sure that the adhesive tape is fully adhered to the vehicle. Repeat for the rear door visor, starting at the pedestal end of the rear door visor and working towards the back of the vehicle.

## FormFit Accessories

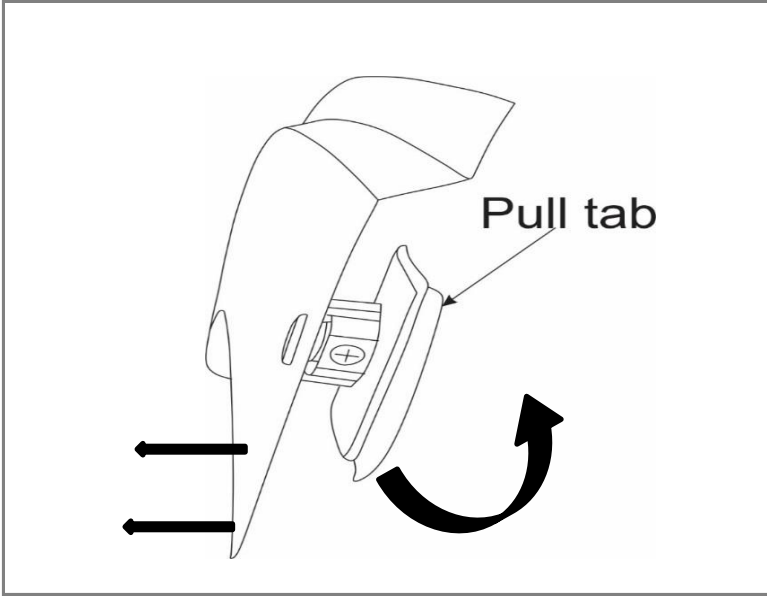

	<b>Attach mounting pedestal</b>	<b>9</b>
--	---------------------------------	----------

<b>N O T E</b>	Gently lift visor away from door frame so the pull tab on the adhesive pedestal is accessible. Pull the red backing from the pedestal and firmly press the visor onto the door frame.
----------------------------	---

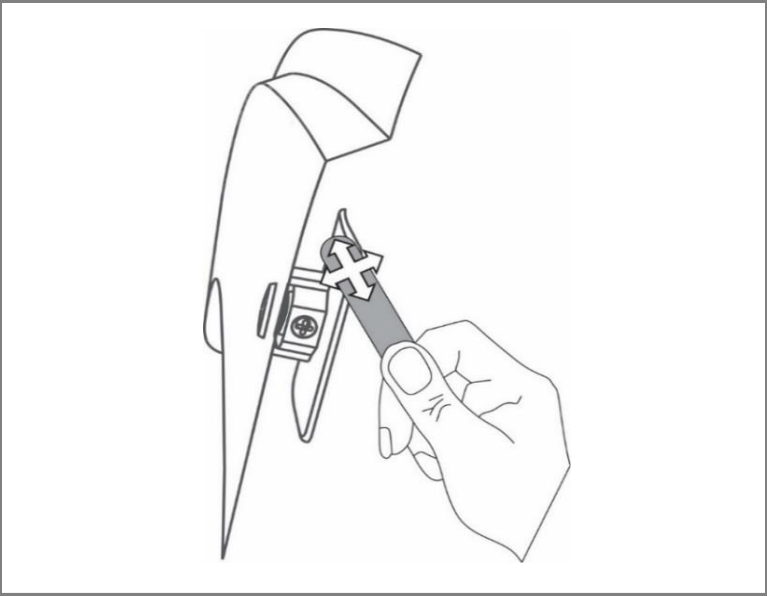

	<b>"Wet out" adhesive pedestal</b>	<b>10</b>
--	------------------------------------	-----------

<b>N O T E</b>	Using the wooden "wet-out" stick supplied, reach under the visor to apply pressure to the surface of the adhesive pedestal. This will make sure there is maximum contact between the adhesive tape and door frame.
	Important: "wetting out" of the pedestals will ensure maximum adhesive bond

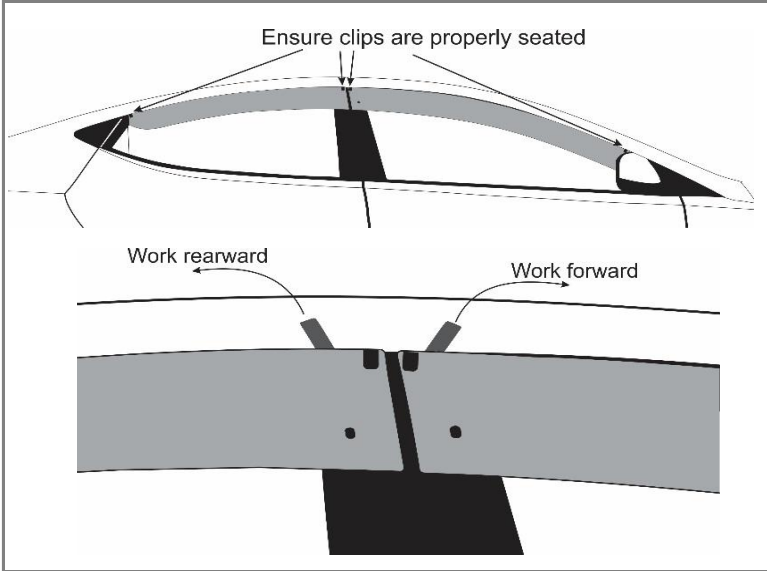

	<b>Attach passenger side visors</b>	<b>11</b>
--	-------------------------------------	-----------

<b>N O T E</b>	Repeat steps 4 through 10 for the remaining visors. Ensure the gaps are consistent with the driver's side. .
----------------------------	--

	<b>Excess adhesive primer can be removed with isopropyl alcohol and a soft cloth or paper towel.</b>
--	--

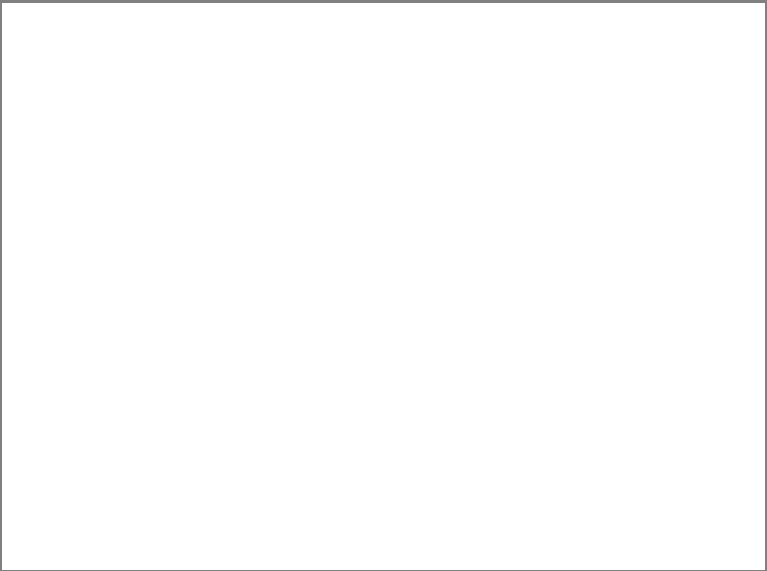

		<b>12</b>
--	--	-----------

<b>N O T E</b>	
----------------------------	--

--	--